

# CENTER<sup>®</sup> 201

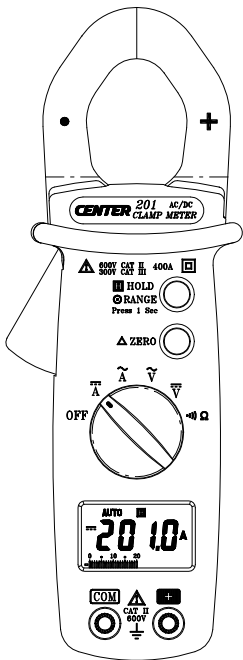

## Instruction Manual

k

### MINI AC/DC CLAMP METER

# CONTENTS

<i>TITLE</i>	<i>PAGE</i>
<b>I. Safety Information</b> .....	1
Environmental Conditions.....	1
Explanation of Symbols.....	1
<b>II. Specification</b> .....	2
General Specification.....	2
Electrical Specification.....	3
<b>III. Instrument Familiarization</b> .....	4
Symbol Definition.....	4
Button instruction.....	5
<b>IV. Measuring Instruction</b> .....	6
4.1 AC Current Measurement.....	6
4.2 DC Current Measurement.....	7
4.3 AC Voltage Measurement.....	8
4.4 DC Voltage Measurement.....	9
4.5 Resistance Measurement.....	10
4.6 Continuity Test.....	11
<b>V. Battery Changing</b> .....	12
<b>VI. Maintenance</b> .....	13

## I. Safety Information

Do not operate the tester if the body of meter or the test lead look broken.

Check the main function dial and make sure it is at the correct position before each measurement.

Do not perform resistance and continuity test on a live power system.

Do not apply voltage between the test terminals and test terminal to ground that exceed the maximum limit record in this manual.

Exercise extreme caution when measuring live system with voltage greater than 60V DC or 30V AC.

Keep the fingers after the protection ring when measuring through the test lead.

Change the battery when the  symbol appears to avoid incorrect data.

### **Environmental Conditions:**

Altitude up to 2000 meters.



Operating temperature: 0°C ~ 40°C, <80% RH, non-condensing

Storage temperature: -10°C ~ 60°C, <70% RH, battery removed

Pollution Degree: 2

Installation Categories II

### **Explanation of Symbols:**

-  Attention! Refer to operation Instructions.
-  Dangerous voltage may be present at terminals.
-  This instrument has double insulation.

**Approvals:**  EN61010 600V CAT II 300V CAT III

## II. Specification

---

### General Specification:

---

**Digital Display:**

3 3/4 digits LCD display with maximum reading 3999

**Analog Display:**

42 segments fast analog bar display

**Symbol and Scale range:**

Adjust automatically according range and input signal

**Polarity:**

When negative signal in apply to the tester,  will show.

**Over Load:**

When the signal larger than the maximum will be show 

**Sample Rate:**

2 times/sec for digital data

20 times/sec for analog bar

**Low Power Indication:**

When the battery is under the proper operation range,  will appear on the LCD display.

**Power Source:** UM-4 or AAA 1.5V battery x 2.

**Power life:** Approx. 50hr (Alkaline Battery )

**Auto Power Off:**

If there is no key or dial operation for 30 minutes, the meter will power itself off to save battery consumption. This function can be disabled by press and hold the ZERO button then power the unit on.

**Clamp opening size:** 30mm

**Dimension (L x W x H) :**

193 x 50 x 28mm, 7.60 x 1.97 x1.1 inch

**Weight:** 240g, 8.46OZ ( include battery)

**Accessory:**

Instruction Manual, Leather Case, Test lead, Battery 1.5Vx2

## Electrical Specification:

The accuracy specification is defined as  $\pm( \dots\% \text{reading} + \dots \text{count} )$   
At  $23 \pm 5^{\circ}\text{C}$ ,  $\leq 80\% \text{RH}$

### DCV (Autorange)

Range	Resolution	Accuracy	Input Impedance	Overload Protection
400V	0.1V	1%+2	10M $\Omega$	660Vrms
600V	1V			

### ACV (Autorange)

Range	Resolution	Accuracy	Input Impedance	Overload Protection
		50Hz~500Hz		
400V	0.1V	1.5%+5	10M $\Omega$	660Vrms
600V	1V			

### DCA (Autorange)

Range	Resolution	Accuracy	Overload Protection
40A	0.01A	2.5%+10	600Arms
400A	0.1A		

### ACA (Autorange)

Range	Resolution	Accuracy	Band Width	Overload Protection
40A	0.01A	2%+10	50Hz~500Hz	600Arms
400A	0.1A			

### Ohm ( $\Omega$ )

Range	Resolution	Accuracy	Max. Test Voltage	Overload Protection
400 $\Omega$	0.1 $\Omega$	1%+2	1.5VDC	600Vrms

### Continuity ( $\rightarrow$ )

Range	Active Region	Max. Test Voltage	Overload Protection
$\rightarrow$	< 40 Ohm	1.5 VDC	600Vrms

### III. Instrument Familiarization:

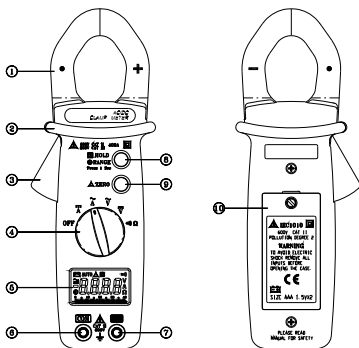

← Current Sensing Clamp

→ Clamp opening handle

◦ LCD display

" Positive input terminal

× Zero button

↑ Safety protection ring

↓ Function select dial

± COM input terminal

≥ Data hold & Manual Range button

∞ Battery cabinet

### Symbol Definition:

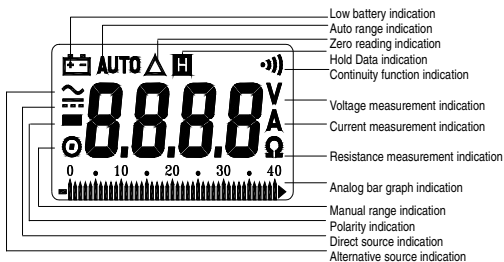

---

## Button Instruction:

---

### ■ Zero Button

Press Zero button to enter the Zero mode, “ $\Delta$ ” annunciate turn on and Zero the display and the reading is stored as reference value for subsequent measurement.

Press it again, the “ $\Delta$ ” annunciate blinking and memorized reference value will display.

Press and hold down zero button for 2 second to exit the zero mode.

When the tester is under zero mode the auto range function will be disabled.

### ■ Data Hold & Manual Range Button

The user may hold the present reading and keep it on the display by pressing the “**Hold**” button.

When the hold data is no longer needed, one may release the data-hold operation by press “**Hold**” button again.

One may hold present reading by press the hold button instantaneously. One may also change the measuring scale range by press and hold the  $\odot$  **RANGE** button. When the decimal point changes, the user should release the button and scale range will stay at the setting range. If the user press and hold the button for more than 2 seconds, the tester will be in auto range mode again.

### ■ Disable Auto power off

Press and hold “ZERO” button and then the power on the meter.

## IV. Measuring Instruction:

### 4.1 AC Current Measurement:

Switch the main function selector to A  $\sim$  range.

Open the clamp by pressing the jaw-opening handle and insert the cable to be measured into the jaw.

Close the clamp and get the reading from the LCD panel.

#### Note:

Before this measurement, disconnect the test lead with the meter for safety.

In some occasion that the reading is hard to read, push the HOLD button and read the result later.

4 CORRECT

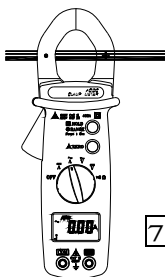
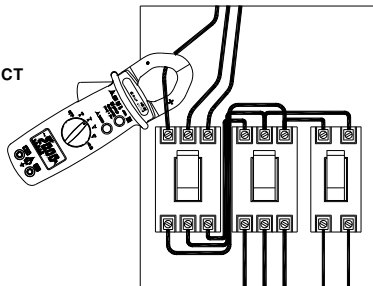

7 INCORRECT

## 4-2 DC Current Measurement

Switch the main function selector to A  $\overline{\text{---}}$  rang.

Press ZERO button to enter the zero reading.

Before measuring current larger than 40A, adjust the scale to 400A range by press the range button then perform auto zero operation.

Open the clamp by pressing the jaw-opening handle and insert the cable to be measured into the jaw.

Close the clamp and get the reading from the LCD panel.

### Note:

Before this measurement, disconnect the test lead with the meter for safety.

In some occasion that the reading is hard to read, push the HOLD button and read the result later.

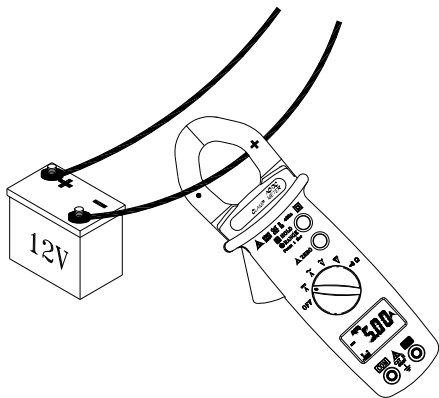

### 4.3 AC Voltage Measurement:

#### **⚠ WARNING!**

Maximum Input Voltage is 600V AC/DC. Do not attempt to Take any voltage measurement that may exceed to avoid Electrical shock hazard and/or damage to this instrument.

Switch the main function selector to V  $\sim$  range.

Connect red test lead to “+” terminal and black one to the “COM” terminal.

Measure the voltage by touch the test lead tips to the test circuit where the value of voltage is needed.

Read the result from the LCD panel.

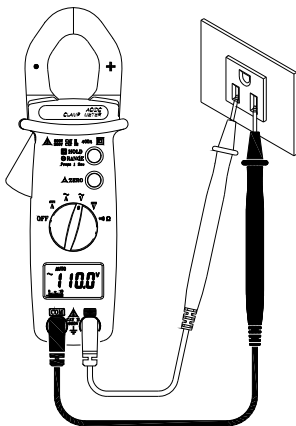

#### 4.4 DC Voltage Measurement:

**⚠ WARNING!**

Maximum Input Voltage is 600V AC/DC. Do not attempt to Take any voltage measurement that may exceed to avoid Electrical shock hazard and/or damage to this instrument.

Switch the main function selector to V  $\text{---}$  range.

Connect red test lead to “+” terminal and black one to the “COM” terminal.

Measure the voltage by touch the test lead tips to the test circuit where the value of voltage is needed.

Read the result from the LCD panel.

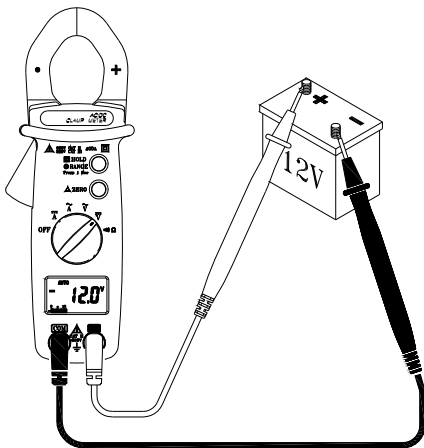

#### 4.5 Resistance Measurement:

Switch the main function to  $\Omega$  range.

Connect red test lead to “+” terminal and black one to the “COM” terminal.

Connect tip of the test leads to the points where the value of the resistance is needed.

Read the result from the LCD panel.

**Note:**

When take resistance value from a circuit system, make sure the power is cut off and all capacitors need to be discharged.

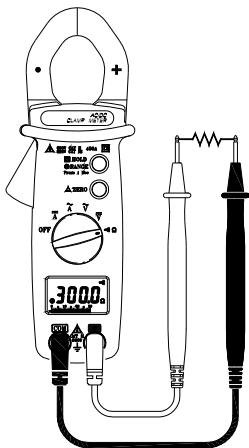

#### 4.6 Continuity Test:

Switch the main function to  range.

Connect red test lead to “+” terminal and black one to the “COM” terminal.

Connect tip of the test leads to the points where the conduction condition needed.

If the resistance is under  $40\ \Omega$ , the beeper will sound continuously.

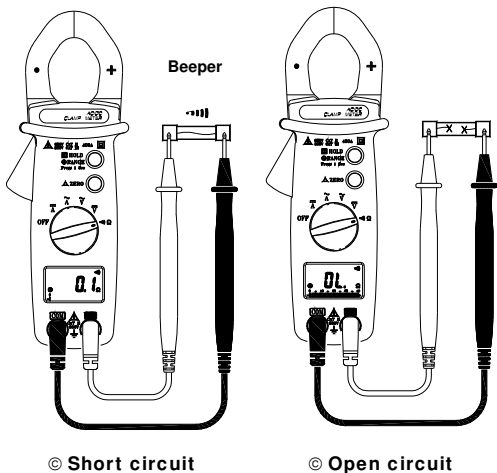



## ***VI. Maintenance:***

---

### **⚠ WARNING!**

Before open the battery door, disconnect both test lead and never uses the meter before the battery door is closed.

---

### **CAUTION**

To avoid contamination or static damage, do not touch the circuit board without proper static protection.

---

### **REMARK**

- \* If the meter is not going to be used for a long time, take out the battery and do not store the meter in high temperature or high humidity environment.
- \* When take current measurement, keep the cable at the center of the clamp will get more accurate test result.
- \* Repairs or servicing not covered in this manual should only by qualified personal.

---

### **CLEANING**

Periodically wipe the case with a dry cloth and detergent. Do not use abrasives or solvents on this instruments.

---

---

***CENTER***<sup>®</sup> CENTER TECHNOLOGY CORP.

4 / F NO. 415, Jung-Jeng Rd., 238 Shu-Lin, Taipei, Taiwan

TEL : 886-2-26763926

E-Mail : center@centertek.com

FAX : 886-2-26763925

http : // www.centertek.com

**201-01**

---

---